

GMM
STONE MACHINERY

EXPERIENCE & QUALITY

Sirio

AUTOMATIC BRIDGE POLISHER / *LUCIDATRICE AUTOMATICA A PONTE*

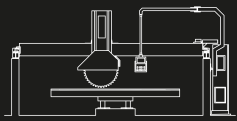

BRIDGE SAWING MACHINES
SEGATRICI A PONTE

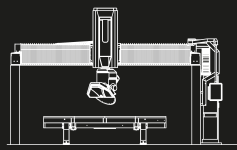

5-AXIS SAWING MACHINES
FRESE 5 ASSI

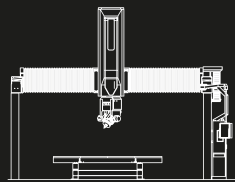

5-AXIS SHAPING MACHINES
SAGOMATRICI 5 ASSI

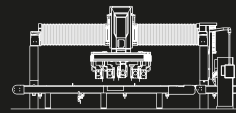

CUTTING CENTER MACHINES
CENTRI DI TAGLIO

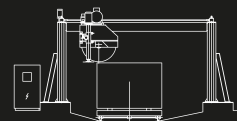

BLOCK CUTTER
TAGLIABLOCCHI

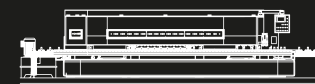

EDGE POLISHER / *LUCIDACOSTE*



CALIBRATING AND POLISHING MACHINES
CALIBRATRICI-LUCIDATRICI

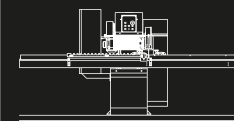

LINES AND
COMPLEMENTARY MACHINERY
*LINEE E MACCHINARI
COMPLEMENTARI*



WATER JET



POWER & CONTROL



EXPERIENCE & QUALITY



TECHNOLOGY & INNOVATION





Automatic bridge polisher

For marble and granite slabs with electronic control of the movements.

The polishing machine SIRIO is the basic tool for any factory in stone processing.

- The basic version can polish:
 - marble slabs using the head with Frankfurt type abrasives;
 - granite slabs using:
 - the optional satellite head with circular grinding wheels with TERZAGO Brevetti couplings;
 - fickert type TANGENTIAL abrasive head.

The plate for marble can be applied on the satellite head with Frankfurt type abrasives.



Lucidatrice automatica a ponte

Per lastre di marmo e di granito con controllo elettronico dei movimenti.

Macchina base per tutti i laboratori del settore lapideo.

- *Nella versione standard può lucidare:*
 - *lastre di marmo utilizzando piatto per marmo con attacchi Frankfurt ad abrasivi formato Frankfurt;*
 - *lastre di granito applicando:*
 - *la testa opzionale A SATELLITI con mole circolari ad attacco Terzago Brevetti;*
 - *la testa ad abrasivi TANGENZIALI tipo Fickert.*

Sulla testa a satelliti può essere applicato il piatto per marmo con attacchi Frankfurt.



Pulidora automática a puente

Para placas de mármol y granito, con control electrónico de los movimientos.

Máquina base para todos los laboratorios del sector pétreo.

- *En la versión estándar puede pulir:*
 - *Placas de mármol utilizando plato para mármol con enganches Frankfurt y abrasivos formato Frankfurt;*
 - *Placas de granito aplicando:*
 - *El cabezal opcional A SATELITES con muelas circulares y enganche Terzago Brevetti;*
 - *El cabezal con abrasivos TANGENCIALES tipo Fickert.*

Sobre el cabezal a satélite puede ser aplicado el plato para mármol con enganches Frankfurt.



TECHNICAL DATA / DATI TECNICI

MAX POLISHING WIDTH <i>LARGHEZZA MASSIMA LUCIDABILE</i>	2100 mm
MAX POLISHING LENGTH WITH STANDARD TRACKS <i>LUNGHEZZA MASSIMA LUCIDABILE CON BINARI STANDARD</i>	4000 mm
LENGTH OF STANDARD TRACKS <i>LUNGHEZZA DEI BINARI STANDARD</i>	6 m
ON REQUEST TRACK OF DIFFERENT LENGTHS (MULTIPLES OF 3 m) <i>ALTRE LUNGHEZZE DI BINARI A RICHIESTA (MULTIPLI DI 3 m)</i>	9-12 m
HORIZONTAL TRAVEL OF THE POLISHING HEAD (X AXIS) <i>CORSA ORIZZONTALE DELLA TESTA LUCIDANTE (ASSE X)</i>	6000-9000*-12000* mm
MAXIMUM BRIDGE TRASLATION (Y AXIS) <i>TRASLAZIONE MASSIMA DEL PONTE (ASSE Y)</i>	2200 mm
VERTICAL TRAVEL OF THE POLISHING HEAD (Z AXIS) <i>CORSA VERTICALE DELLA TESTA LUCIDANTE (ASSE Z)</i>	300 mm
POWER OF THE POLISHING HEAD MOTOR <i>POTENZA MOTORE DELLA TESTA LUCIDANTE</i>	18 kW
POWER OF THE AUXILIARY MOTOR <i>POTENZA MOTORE AUSILIARIO</i>	3 kW
TRANSLATION SPEED ON TRACKS <i>VELOCITÀ DI TRASLAZIONE SUI BINARI</i>	0÷18 m/min
MOTION SPEED OF THE HEAD HOLDER SLIDE <i>VELOCITÀ DI MOVIMENTO SLITTA PORTA TESTA</i>	0÷16 m/min
PNEUMATICALLY REGULATED WORKING PRESSURE BAR <i>PRESSIONE DI LAVORO A REGOLAZIONE PNEUMATICA</i>	0÷6 bar
ROTATION SPEED OF THE HEAD <i>VELOCITÀ DI ROTAZIONE DELLA TESTA</i>	350 rpm
COOLING WATER CONSUMPTION AT 3 BAR <i>CONSUMO ACQUA DI REFRIGERAZIONE A 3 BAR</i>	40 l/min
PRODUCTION CAPACITY FOR MARBLE SLABS <i>PRODUZIONE SU LASTRE DI MARMO</i>	5÷7 mq/h
PRODUCTION CAPACITY FOR GRANITE SLABS <i>PRODUZIONE SU LASTRE DI GRANITO</i>	3÷4 mq/h
TOTAL MACHINE MASS <i>MASSA COMPLESSIVA</i>	4200 kg

*OPTIONAL



Programming and control unit
Unità di programmazione e controllo

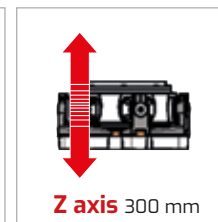
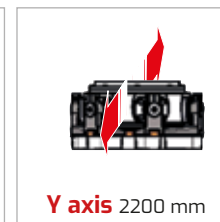
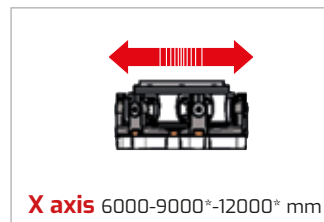

TECHNOLOGY & INNOVATION

EXPERIENCE & QUALITY

POWER & CONTROL

Sirio

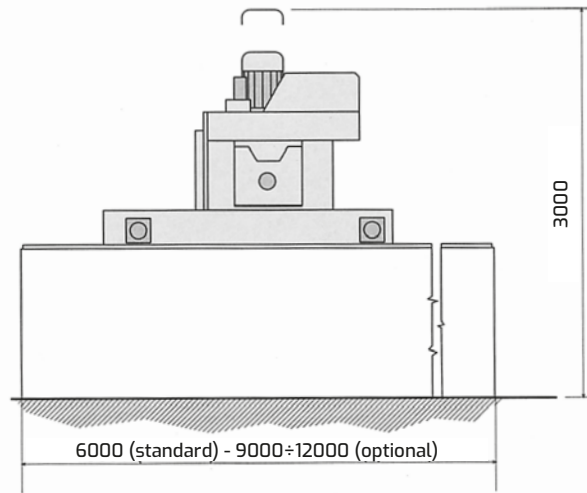

OPTIONAL ON REQUEST / OPZIONALI A RICHIESTA

COD. A7211
SATELLITE HEAD FOR GRANITE
TESTA PER GRANITO A SATELLITE



COD. A7282
TANGENTIAL HEAD FOR GRANITE
TESTA PER GRANITO TANGENZIALE



COD. A7215
HEAD FOR MARBLE
TESTA PER MARMO



COD. A7213
BUSH-HAMMERING PLATE
PIATTO PER BOCCIARDARE

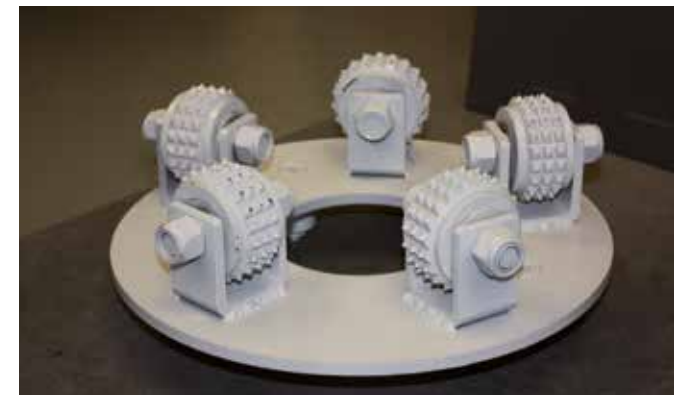

GMM

STONE MACHINERY



GMM S.P.A.
HEADQUARTER
ITALY
www.gmm.it

GMM S.P.A. SCHIO
BUSINESS UNIT
ITALY
www.gmm.it

GMM USA INC.
COMMERCIAL / AFTER SALES UNIT
USA
www.gmm.it

GMM INTERNATIONAL LTD.
COMMERCIAL / AFTER SALES UNIT
HONG KONG
www.gmmchina.cn

GMM (QUANZHOU) LTD.
COMMERCIAL / AFTER SALES UNIT
CHINA
www.gmmchina.cn

GMM STEINBEARBEITUNGSMASCHINEN GMBH
COMMERCIAL / AFTER SALES UNIT
GERMANY
www.gmm-steinbearbeitung.de

BAVELLONI SPA
HEAD OFFICE / PRODUCTION UNIT
ITALY
www.bavelloni.com

BAVELLONI SPA
TOOLS DIVISION / PRODUCTION UNIT
ITALY
www.bavelloni.com

BAVELLONI AMERICA INC.
COMMERCIAL / AFTER SALES UNIT
USA
www.bavelloni.com

BAVELLONI DO BRASIL
COMERCIO DE MAQUINAS LTDA
COMMERCIAL / AFTER SALES UNIT
BRAZIL
www.bavelloni.com

Z.BAVELLONI MÉXICO S.A. DE C.V.
COMMERCIAL / AFTER SALES UNIT
MEXICO
www.bavelloni.com

TECHNI WATERJET LTD.
MELBOURNE HEAD OFFICE
AUSTRALIA
www.techniwaterjet.com

TECHNI WATERJET LTD.
PRODUCTION UNIT
THAILAND
www.techniwaterjet.com

TECHNI WATERJET LLC
COMMERCIAL / AFTER SALES UNIT
USA
www.techniwaterjet.com

WPA WATERJET
PRODUCTION ACADEMY GMBH
DISTRIBUTOR
GERMANY
www.wpa-gmbh.com

MECTOCE S.R.L.
PRODUCTION UNIT
ITALY
www.mectoce.it

Sirio



CALIBRATING AND POLISHING MACHINES / CALIBRATRICI-LUCIDATRICI

Astro | LMS 650-850-1000 | LMS 2100 | Levicompat 620-800 | Everest 650-850-1000-1200 | Everest 2100 | Heads / Teste

Technical data are not binding and may be changed by GMM without prior notice.
I dati tecnici non sono impegnativi e possono essere modificati da GMM senza preavviso.

IMPORTANT: machines displayed in the present catalogue are without safety barriers in order to ensure the perfect vision of all the details of the machine. All machines will be delivered and installed with safety barriers as per current legislation. The data in the present catalogue may vary without notice due to continuous update of technology.

IMPORTANTE: alcune macchine sono sprovviste di alcune protezioni per meglio evidenziare le caratteristiche del prodotto. Alla consegna e alla installazione, tutte le macchine saranno munite delle protezioni secondo le vigenti norme di legge. I dati del presente depliant non sono impegnativi perché soggetti a possibili variazioni senza preavviso per aggiornamenti e continue evoluzioni tecnologiche.

ISO 9001
BUREAU VERITAS
Certification



Member of:
CONFINDUSTRIA MARMOMACCHINE
ASSOCIOMAROCCHI



ISO 9001:2015 - Certificato N°IT234871